

File Name:	MEITRACK MVT600 User Guide	Creator:	Cavana Cheung
Project:	MVT600	Creation Date:	2010-09-13
		Update Date:	2013-06-26
Sub Project:	User Guide	Page:	- 1 - of 22
Revision:	V3.0	Confidential:	External Documentation

---

# MEITRACK® GPS Vehicle Tracker



## User Guide

## MVT600



File Name:	MEITRACK MVT600 User Guide	Creator:	Cavana Cheung
Project:	MVT600	Creation Date:	2010-09-13
		Update Date:	2013-06-26
Sub Project:	User Guide	Page:	- 2 - of 22
Revision:	V3.0	Confidential:	External Documentation

---

## Contents

1.	Copyright and Disclaimer .....	- 3 -
2.	Applications.....	- 3 -
3.	Product Function and Specifications .....	- 3 -
3.1	Product Function .....	- 3 -
3.2	Specifications .....	- 4 -
4.	MVT600 and Accessories .....	- 5 -
5.	View.....	- 5 -
6.	First Use.....	- 6 -
6.1	Install SIM Card .....	- 6 -
6.2	Charging .....	- 6 -
6.3	LED Indications.....	- 6 -
6.4	Track by Calling .....	- 7 -
6.4.1	Multiple Phone numbers– A71 .....	- 8 -
6.4.2	Listening-in (Voice Monitoring)–A72 .....	- 8 -
6.4.3	Sleep Mode – A73 .....	- 9 -
6.4.4	Geo-fence Alarm – B05.....	- 9 -
6.4.5	Set Anti-theft – B21 .....	- 10 -
6.4.6	Time Zone– B35.....	- 10 -
6.5	Configure by Computer .....	- 10 -
6.5.1	SMS Tracking.....	- 12 -
6.5.2	GPRS Tracking .....	- 15 -
7	Installation.....	- 17 -
7.1	Install I/O Cable.....	- 17 -
Power/GND (PIN1/PIN2).....	- 18 -	
7.1.2	Digital Input (PIN4/5, negative triggering) .....	- 18 -
7.1.3	Digital Input (PIN3, positive triggering) .....	- 18 -
7.1.4	Output .....	- 19 -
7.1.5	Analog Input .....	- 19 -
7.1.6	Install Handset Phone (RS232 Interface).....	- 20 -
7.1.7	Install Camera (RS232 Interface).....	- 20 -
7.1.8	Install Micro SD.....	- 21 -
7.1.9	Install RFID Reader (Wiegand Interface).....	- 21 -
7.2	Install GPS/GSM Antennas .....	- 21 -
7.3	Mount the MVT600 unit .....	- 22 -



File Name:	MEITRACK MVT600 User Guide	Creator:	Cavana Cheung
Project:	MVT600	Creation Date:	2010-09-13
		Update Date:	2013-06-26
Sub Project:	User Guide	Page:	- 3 - of 22
Revision:	V3.0	Confidential:	External Documentation

---

## 1. Copyright and Disclaimer

Copyright © 2013 MEITRACK. All rights reserve

MEITRACK and  are trademarks that belong to Meitrack Group

The user manual may be changed without prior notification.

This user manual, or any part thereof, may not be reproduced for any purpose whatsoever without the written authorization of Meiligao (MEITRACK), or transmitted in any form, either electronically or mechanically, including photocopying and recording.

In no event shall Meiligao (MEITRACK) be liable for direct, indirect, special, incidental, or consequential damages (including but not limited to economic loss, personal injury, and loss of asset and property) arising out of the use or inability or illegality to use the product or documentation.

## 2. Applications

- Vehicle Real Time Tracking
- Car Security/Anti-Hijack
- Fleet Management

## 3. Product Function and Specifications

### 3.1 Product Function

- SiRF III GPS and Quad Band GSM 850/900/1800/1900Mhz
- AGPS ( with GSM Base Station ID)
- Track by SMS/GPRS (MEITRACK Protocol)
- Track on Demand
- Track by Time Interval
- Track by Distance Interval
- Track on Mobile Phone
- Listen-in or Two-way Audio (Optional)
- Internal Flash Memory (8M)
- Inbuilt Accelerating Sensor
- Inbuilt Motion Sensor
- Internal Backup Battery
- SOS Alarm
- Geo-fence Alarm
- GPS Blind Area Alarm
- Low Battery Alarm



File Name:	MEITRACK MVT600 User Guide	Creator:	Cavana Cheung
Project:	MVT600	Creation Date:	2010-09-13
		Update Date:	2013-06-26
Sub Project:	User Guide	Page:	- 4 - of 22
Revision:	V3.0	Confidential:	External Documentation

- Speeding Alarm
- Tow Alarm
- GPS Antenna Cut Alarm
- External Power Cut Alarm
- Mileage Report
- Engine Cut (Engine immobilization)
- Inbuilt Super Magnet (optional)
- Handset Phone (optional)
- Camera (optional)
- Micro SD Card Memory for Storing Pictures (Optional)
- RFID Reader (optional)
- LED Display (optional)
- LCD Display (optional)
- 3 Digital Inputs
- 3 Outputs
- 3 Analog Input Detection

### 3.2 Specifications

Items	Specifications
Dimension	103*98*32mm
Weight	220g
Input Voltage	DC 9V~36V/1.5A
Back-up Battery	850mAh/3.7V
Power consumption	85mA standby current
Operating Temperature	-20°C~55°C
Humidity	5%~95%
Work Time	36 hours in power-saving mode and 8 hours in normal mode
LED	2 LED lights to show GPS, GSM and other status
Button	1 SOS and 1 power on/off
Microphone	Optional
Memory	8M Byte
Sensor	Motion and Accelerating sensor
GSM Frequency	GSM 850/900/1800/1900MHz
GPS Chip	Latest GPS SIRF-Star III chipset
GPS Sensitivity	-159dB
Positioning Accuracy	10 meters, 2D RMS
I/O	3 Digital Input ( 1 positive triggering and 2 negative triggering)

File Name:	MEITRACK MVT600 User Guide	Creator:	Cavana Cheung
Project:	MVT600	Creation Date:	2010-09-13
Sub Project:	User Guide	Update Date:	2013-06-26
Revision:	V3.0	Page:	- 5 - of 22
		Confidential:	External Documentation

3 Analog Input Detection
3 Output
4 RS232 Interface

#### 4. MVT600 and Accessories



#### Optional Accessories



#### 5. View



File Name:	MEITRACK MVT600 User Guide	Creator:	Cavana Cheung
Project:	MVT600	Creation Date:	2010-09-13
		Update Date:	2013-06-26
Sub Project:	User Guide	Page:	- 6 - of 22
Revision:	V3.0	Confidential:	External Documentation

## 6. First Use

### 6.1 Install SIM Card

Check that the SIM has not run out of credit (test the SIM in a phone to make sure it can send and receive SMS);

Check that the SIM Lock code is turned off;

If you require the function of sending an SMS location report to the authorized phone number when it makes a call to the MVT600, please make sure the SIM installed supports displaying caller ID.



Before installing the SIM card, turn off the power for MVT600.

Unscrew and remove cover.

Insert the SIM card by sliding it into the card holder with the chip module facing to the connectors on PCB.

Replace the cover and screw it in.

### 6.2 Charging

Please connect GND (-Black) and Power (+Red) wires to 12V or 24 external power and make sure to charge the battery for at least 3 hours. 8 hours is highly appreciated.

Configuration and testing suggested be prior to installation.

### 6.3 LED Indications

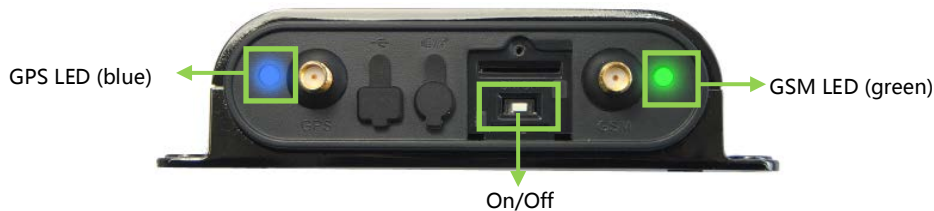

Press and hold the Power On/Off button for 3~5 seconds to turn on/off MVT600.

GPS LED (Blue)	
On	One button is pressed or input is active.
Flashing ( every 0.1 second)	Initializing or back-up battery power is low
Flashing (0.1 second on and 2.9 seconds off)	MVT600 has a GPS fix
Flashing (1 second on and 2 seconds off)	MVT600 has no GPS fix
GSM LED (Green)	
On	A call is coming in / a call is being made
Flashing ( every 0.1 second)	Initializing

File Name:	MEITRACK MVT600 User Guide	Creator:	Cavana Cheung
Project:	MVT600	Creation Date:	2010-09-13
Sub Project:	User Guide	Update Date:	2013-06-26
Revision:	V3.0	Page:	- 7 - of 22
		Confidential:	External Documentation

Flashing (0.1 second on and 2.9 seconds off)	MVT600 is connected to the GSM network
Flashing (1 second on and 2 seconds off)	MVT600 is not connected to the GSM network

## 6.4 Track by Calling

Make a call to MVT600 and it will report with one SMS.

For example,

Now,110727 02:48,V,16,23Km/h,61%,<http://maps.google.com/maps?f=q&hl=en&q=22.540103,114.082329&ie=UTF8&z=16&iwloc=addr&om=1>



Click on the link then the location can be shown directly on Google Maps on your mobile phone.

Report description:

Now,110727 02:48,V,16,23Km/h,61%,<http://maps.google.com/maps?f=q&hl=en&q=22.540103,114.082329&ie=UTF8&z=16&iwloc=addr&om=1>

Content	Description	Note
Now	Current Location	Alarm Type
110721 16:40	Date & Time: 21 July, 2011, 16:40pm	Date & Time in YYMMDD HH:MM
V	No GPS fixed	GPS Status Indicator: A = valid, V = invalid
10	GSM signal=10	GSM Signal. Decimal Digit (0~31)
0Km/h	Speed=0	KM/h. Decimal digit
97%	Battery Power: 97%	Battery Power Balance (Percentage)
<a href="http://maps.google.com/maps?f=q&amp;hl=en&amp;q=22.540103,114.082329&amp;ie=UTF8&amp;z=16&amp;iwloc=addr&amp;om=1">http://maps.google.com/maps?f=q&amp;hl=en&amp;q=22.540103,114.082329&amp;ie=UTF8&amp;z=16&amp;iwloc=addr&amp;om=1</a>	Latitude: 22.513015 Longitude: 114.057235	Google Maps Web Link with Latitude and Longitude. Click on the link to get the location.

If your mobile cannot visit HTTP websites, input the latitude and longitude into Google Maps as the following picture shows to get the position:

File Name:	MEITRACK MVT600 User Guide	Creator:	Cavana Cheung
Project:	MVT600	Creation Date:	2010-09-13
Sub Project:	User Guide	Update Date:	2013-06-26
Revision:	V3.0	Page:	- 8 - of 22
		Confidential:	External Documentation

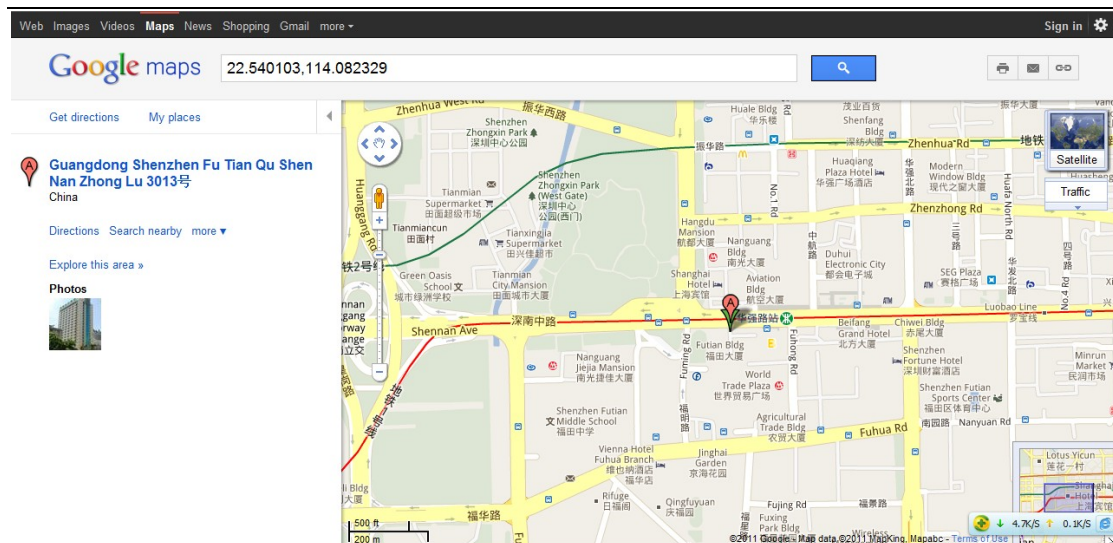

### More SMS commands

You can configure MVT600 by mobile phone or by computer using the MEITRACK Parameter Editor.

For more details, please refer to part 6.5 **Configure by Computer**.

*Note:*

1. *Password is 4 digits only and defaulted as 0000. You can change the password by Parameter Editor and SMS command.*
2. *MVT600 will only accept commands from a user with the correct password and report SMS report to the user. If preauthorized phone number was set, only this phone number can receive SMS reports.*

#### 6.4.1 Multiple Phone numbers– A71

**Command:** 0000, A71, phone number 1, phone number 2, phone number 3

**SMS Get:** IMEI, A71, OK

**Note:**

Authorize a phone number for SOS alarm, calling for location report, geo-fence alarm, and low battery alarm.

Phone Number: Max 16 characters.

If no preset phone number, it is empty (default is empty).

Send command "0000, A71" to delete all phone numbers.

When the SOS button is pressed, MVT600 will make a call to phone number 1, 2 and 3. It will stop calling when one number answers.

**Example:** 0000,A71,13811111111,13822222222,13833333333

**SMS Get:** 353358017784062,A71,OK

#### 6.4.2 Listening-in (Voice Monitoring)–A72

**Command:** 0000, A72, phone number 1, phone number 2

**SMS Get:** IMEI, A72, OK

**Note:**





File Name:	MEITRACK MVT600 User Guide	Creator:	Cavana Cheung
Project:	MVT600	Creation Date:	2010-09-13
		Update Date:	2013-06-26
Sub Project:	User Guide	Page:	- 9 - of 22
Revision:	V3.0	Confidential:	External Documentation

Authorize a phone number to make a silent call to the tracker. The tracker will answer the call automatically and allows the caller to listen to what is happening around the tracker. There is no sound when the tracker is working.

Phone Number: 2 monitoring numbers at the most can be set, 16 characters per number.

If no preset phone number, it is empty (default).

If no phone number, but has “;”, the number related to this “;” is deleted.

Send command “0000,A72” to delete all phone numbers.

**Example:** 0000,A72,13844444444,13855555555

**SMS Get:** 353358017784062,A72,OK

### 6.4.3 Sleep Mode – A73

**Command:** 0000,A73,X

**SMS Get:** IMEI,A73,OK

**Note:**

This setting is for power saving.

X=0, turn off sleep mode (default)

X=1, normal sleep. GSM module work, GPS module work by sleep mode intermittently. The device can work 25% longer than no sleep mode. Note: this is not recommended for users who set “track by interval” or short time interval, because it will affect the completeness of tracking.

X=2, deep sleep, the tracker will enter this mode after it is inactive or stationary(No SOS/any triggered by the button/input/incoming calls/message/movement) for 5 minutes. GPS module stops working and GSM module enters sleep mode. The tracker remains in this mode until it is activated by SOS/any triggered by the button/input/incoming calls/message/movement. After that, it will repeat above processes.

Note: In any condition, the device will directly quit the sleep mode and back to normal working mode by SMS or GPRS command to turn off the sleep mode.

**Example:** 0000,A73,2

**SMS Get:** 353358017784062,A73,OK

### 6.4.4 Geo-fence Alarm – B05

**Command:** B05,P,latitude,longitude,radius,in,out

**SMS Get:** IMEI,B05,OK

**Note:**

P: 1 to 8. Max 8 Geo-fence waypoints can be set.

Latitude: Latitude in decimal degrees of the waypoint center.

Longitude: Longitude in decimal degrees of the waypoint center.

Radius: [1, 4294967295] in meters.

In = 0, turn off the alarm when the tracker enters the waypoint;

In = 1, turn on the alarm when the tracker enters the waypoint.

Out = 0, turn off the alarm when the tracker exits the waypoint;

Out = 1, turn on the alarm when the tracker exits the waypoint.



File Name:	MEITRACK MVT600 User Guide	Creator:	Cavana Cheung
Project:	MVT600	Creation Date:	2010-09-13
		Update Date:	2013-06-26
Sub Project:	User Guide	Page:	- 10 - of 22
Revision:	V3.0	Confidential:	External Documentation

---

**Example:** 0000,B05,1,22.91319,114.07988,1000,0,1

**SMS Get:** 353358017784062,B05,OK

*Once the tracker goes outside of the circle (center: 22.91319,114.07988 and radius 1000 meters), the following message will be received.*

*353358017784062,ExitGEO,22.918186,114.089823,080229123816,A,10,22,16,32,1,21,6667,850,,0000*

#### 6.4.5 Set Anti-theft – B21

**Command:** 0000,B21,Status

**SMS Get:** IMEI,B21,OK

**Note:**

Status=1, turn on Anti-theft (default); the device alarms when input 2 (negative input) and input 3 (positive input) are active;

Status=0, turn off Anti-theft; the device doesn't alarm when input 2 (negative input) and input 3 (positive input) are active.

#### 6.4.6 Time Zone– B35

**Command:** 0000,B35,T

**SMS Get:** IMEI,B35,OK

**Note:**

Default time of the tracker is GMT. You can use this command to change the time on your tracker to your local time. This command is for SMS tracking only.

Time zone of SMS report is separated with that of GPRS data. If you need to set time zone in GPRS data, please use SMS command: 0000, B36, T

T=0, to turn off this function.

T=[-32768,32767] to set time difference in minutes to GMT.

For those ahead of GMT, just input the time difference in minutes directly. For example, GMT+8, W000000,032,480

'-' is required for those behind GMT. For example, W000000,032,-120.

**Example:** 0000,B35,480

**SMS Get:** 353358017784062,B35,OK

*For more details regarding SMS commands, please refer to MEITRACK SMS Protocol.*

## 6.5 Configure by Computer

This part shows you the basics in how to use the **MEITRACK Parameter Editor**.

**Note: Don't connect MVT600 to external battery when configuring.**

Please refer to the **MEITRACK Parameter Editor User Guide** for more detailed information regarding configuration and functions.

File Name:	MEITRACK MVT600 User Guide	Creator:	Cavana Cheung
Project:	MVT600	Creation Date:	2010-09-13
		Update Date:	2013-06-26
Sub Project:	User Guide	Page:	- 11 - of 22
Revision:	V3.0	Confidential:	External Documentation

Run 'PL2303\_Prolific\_DriverInstaller' to install the driver for the USB data cable.

*Note: PL2303\_Prolific\_DriverInstaller is in the folder 'USB-232 Driver' in the CD.*

Connect the USB Data Cable between MVT600 and PC.



Open **Device Manager** (Device Manager is under Control Panel\System and Security\System). You can then find 'Prolific USB-to-Serial Comm Port' as the following picture shows.

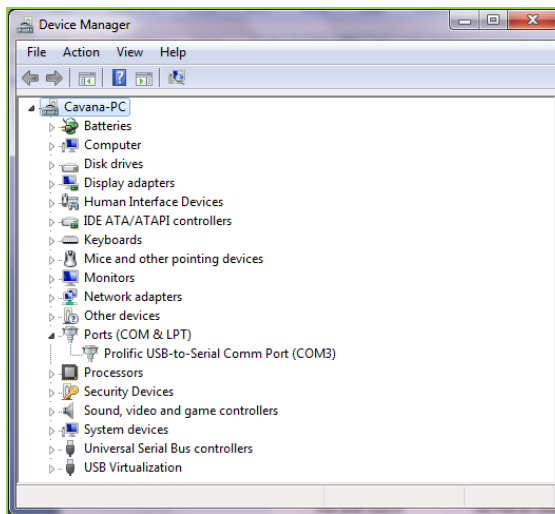

*Note: Remember this Com number. It needs to be input into the MEITRACK Parameter Editor. It is COM3 in this example and it would be COM4 or COM5... in your computer.*

Run 'MEITRACK Parameter Editor.exe' and the following configuration window will pop up:

File Name:	MEITRACK MVT600 User Guide	Creator:	Cavana Cheung
Project:	MVT600	Creation Date:	2010-09-13
Sub Project:	User Guide	Update Date:	2013-06-26
Revision:	V3.0	Page:	- 12 - of 22
		Confidential:	External Documentation

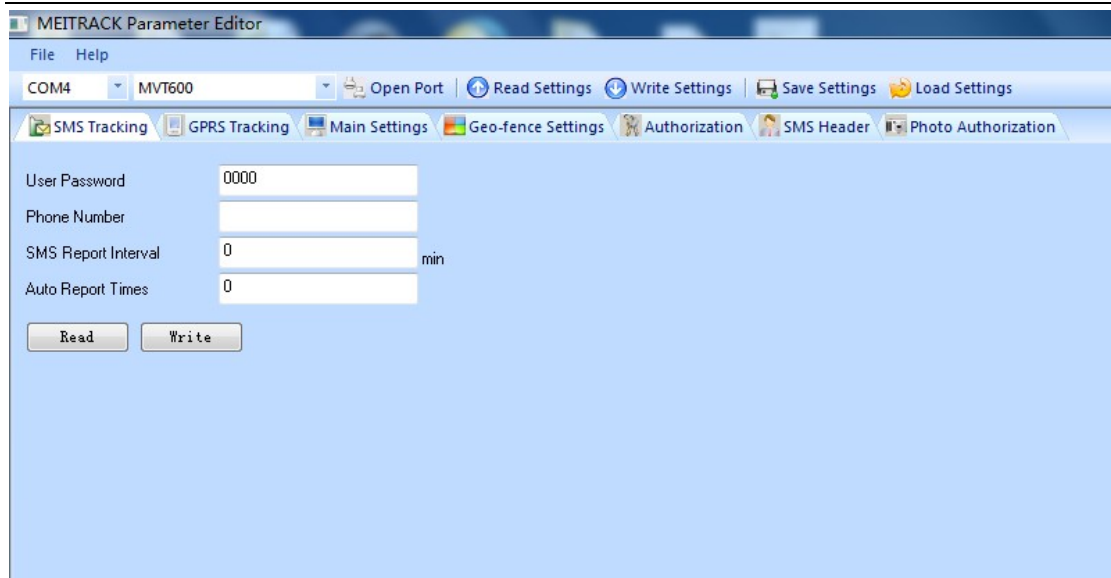

Choose the correct Com number and terminal type in previous Device Manager then click the 'Open Port' button. Click 'Read Settings' button to show the default or previous settings of the tracker.

*Note: MEITRACK Parameter Editor is in the CD. The language will be automatically adjusted to be the same as your PC operation system's language. Please use "Ctrl+L" to change the language.*

## 6.5.1 SMS Tracking

### 6.5.1.1 Track by Preset Interval

Click Tap I: SMS Tracking

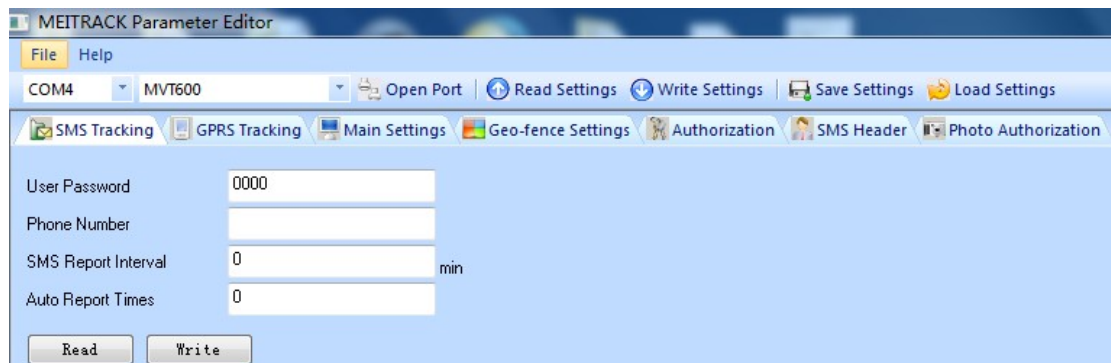

Item	Description
<b>User Password</b>	SMS password for sending SMS commands and defaulted as 0000.
<b>Phone Number</b>	A phone number to receive SMS location reports.
<b>SMS Report Interval</b>	Track by time interval via SMS. Set time interval for SMS location report. = 0, stop tracking by time interval (default); = [1,65535], track by interval in minute.
<b>Auto Report Times</b>	= 0, unlimited times for report.



File Name:	MEITRACK MVT600 User Guide	Creator:	Cavana Cheung
Project:	MVT600	Creation Date:	2010-09-13
		Update Date:	2013-06-26
Sub Project:	User Guide	Page:	- 13 - of 22
Revision:	V3.0	Confidential:	External Documentation

	= [1,255], it will stop reporting when reaching preset times
<b>Read</b>	Read current tracker's settings for above items.
<b>Write</b>	Write above settings to the tracker.

### 6.5.1.2 SMS Report

Click Tap V: Authorization

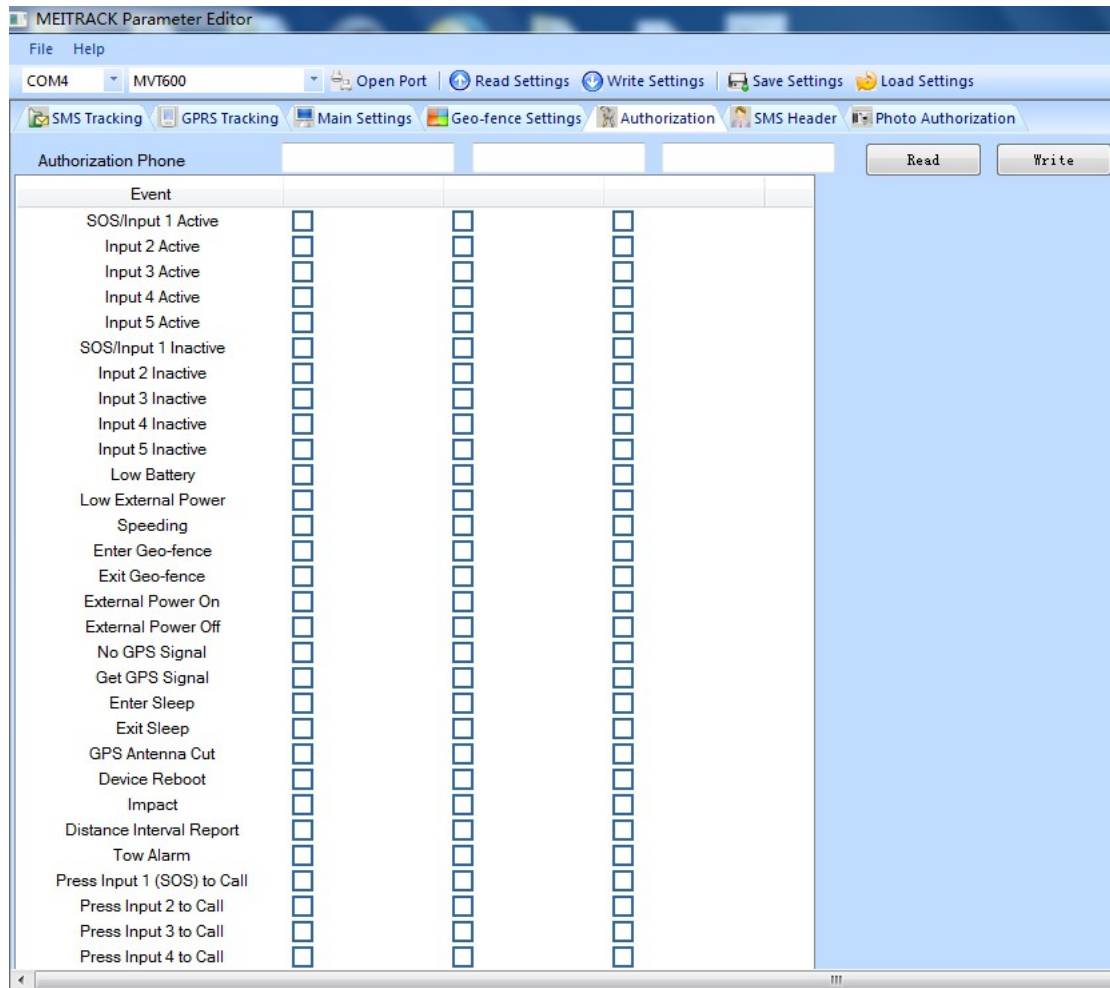

Item	Description
<b>Authorization Phone</b>	A phone number to receive selected event's SMS reports.
<b>Event</b>	Selected event's SMS reports will be sent to the authorized phone number. For more details, please refer to MEITRACK GPRS/SMS Protocol. For description of events from SOS/Input 1 Active to Tow Alarm, please refer to tap II <b>GPRS Tracking</b> . Other events description, please refer to below chart.
<b>Read</b>	Read current tracker's settings for above items.
<b>Write</b>	Write above settings to the tracker.

File Name:	MEITRACK MVT600 User Guide	Creator:	Cavana Cheung
Project:	MVT600	Creation Date:	2010-09-13
		Update Date:	2013-06-26
Sub Project:	User Guide	Page:	- 14 - of 22
Revision:	V3.0	Confidential:	External Documentation

**Event Description:**

Event	Description (If the box is ticked, authorized phone number will get event report by SMS or calling)
<b>SOS/Input 1 Active</b>	Report when input1 (SOS) is active/pressed.
<b>Input 2 Active</b>	Report when input 2 is active.
<b>Input 3 Active</b>	Report when input 3 is active.
<b>SOS/Input1 Inactive</b>	Report when input 1 inactive (SOS released).
<b>Input 2 Inactive</b>	Report when input 2 inactive.
<b>Input 3 Inactive</b>	Report when input 3 inactive.
<b>Low Battery</b>	Report when backup battery's voltage is below 3.5V.
<b>Low External Power</b>	External power (car battery) is lower than predefined voltage. You can define voltage in Main Settings.
<b>Speeding</b>	Report when MVT600 speeds higher than the pre-set value. Value can be changed on tap III <b>Main Settings</b>
<b>Enter Geo-fence</b>	Report when MVT600 enters Geo-fence.
<b>Exit Geo-fence</b>	Report when MVT600 exits Geo-fence. Geo-fence can be changed on tap III <b>Main Settings</b> .
<b>External Power On</b>	Alarm when external power supply is on or recover.
<b>External Power Off</b>	Alarm when external power supply if off or cut.
<b>No GPS Signal</b>	Report when MVT600 enters GPS blind area or no GPS signal.
<b>Get GPS Signal</b>	Report when MVT600 exits GPS blind area or get GPS signal.
<b>Enter Sleep</b>	Report when MVT600 enters sleep mode.
<b>Exit Sleep</b>	Report when MVT600 exits sleep mode. Sleep mode can be changed on tap III <b>Main Settings</b> .
<b>GPS Antenna Cut</b>	Alarm when the GPS antenna is disconnected or cut
<b>Device Reboot</b>	Report when MV600 is rebooting.
<b>Heartbeat Report</b>	Turn on heartbeat report You can define heartbeat interval on tap III <b>Main Settings</b> .
<b>Heading Change Report</b>	Auto report when MVT600's direction changes over predefined angle You can define angle degree on tap III <b>Main Settings</b> .
<b>Distance Interval Report</b>	Track by distance. Interval can be changed on tap III <b>Main Settings</b> .
<b>Tow Alarm</b>	Alarm when the tracker trembles for a period of time. You can define tow time on tap III <b>Main Settings</b> .
<b>Press Input 1 (SOS) to call</b>	Make a call to authorized phone number when press input 1 (SOS).
<b>Press Input 2 to call</b>	Make a call to authorized phone number when press input 2.

File Name:	MEITRACK MVT600 User Guide	Creator:	Cavana Cheung
Project:	MVT600	Creation Date:	2010-09-13
		Update Date:	2013-06-26
Sub Project:	User Guide	Page:	- 15 - of 22
Revision:	V3.0	Confidential:	External Documentation

<b>Press Input 3 to call</b>	Make a call to authorized phone number when press input 3.
<b>Reject Incoming Call</b>	Hand up automatically incoming call from correspondent authorized phone number.
<b>Call for SMS Location Report</b>	Reject incoming call or report SMS location when no answer.
<b>Auto Answer Incoming Call</b>	Auto answer the incoming call for conversation
<b>Listen-in (voice monitoring)</b>	Auto answer the incoming call for voice monitoring

### 6.5.2 GPRS Tracking

Click Tap II: GPRS Tracking

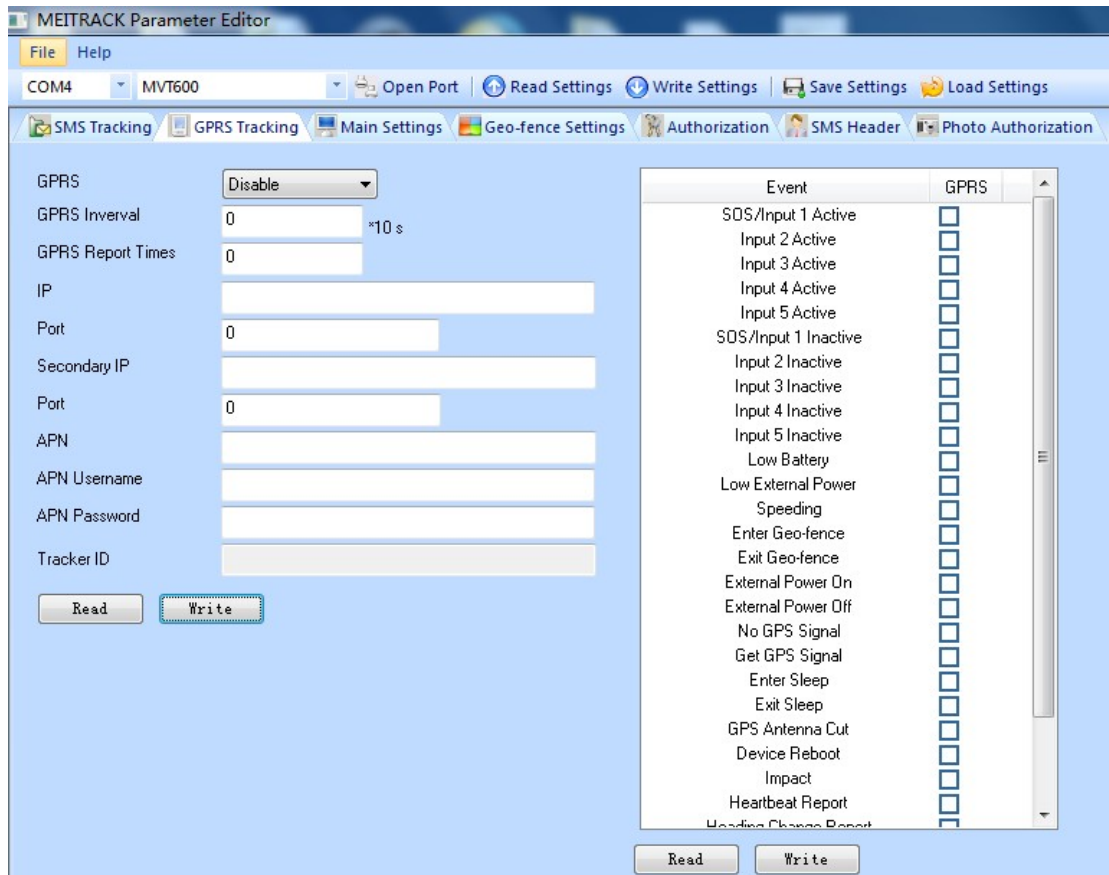

Item	Description
<b>GPRS</b>	Select TCP/UDP to enable GPRS communication.
<b>GPRS Interval</b>	Track by time interval via GPRS. Set time interval for GPRS tracking. Interval is in unit of 10 seconds. Interval = 0, stop tracking by time interval. Max time interval = 65535*10 seconds
<b>GPRS Report Times</b>	= 0, report without limit. = [1,65535], set report times, MVT600 will stop reporting when reaching

File Name:	MEITRACK MVT600 User Guide	Creator:	Cavana Cheung
Project:	MVT600	Creation Date:	2010-09-13
		Update Date:	2013-06-26
Sub Project:	User Guide	Page:	- 16 - of 22
Revision:	V3.0	Confidential:	External Documentation

	the times.
<b>IP &amp; Port</b>	Input server's IP address and port number.
<b>Secondary IP and Port (Backup Server)</b>	Input backup server's IP address and port number to avoid data losing when main server is down. The backup server will receive data automatically.
<b>APN</b> <b>APN user name</b> <b>APN password</b>	APN, APN username, APN password: max 32 bytes. If no username and password required, leave them blank.
<b>Tracker ID</b>	MVT600's IMEI. It is the only ID in GPRS packet.
<b>Read</b>	Read current tracker's settings for above items.
<b>Write</b>	Write above settings to the tracker.

Tick the box for receiving GPRS report.

**Event Description:**

<b>Event</b>	<b>Description</b> <b>(If the box is ticked, authorized phone number will get event report by SMS or calling)</b>
<b>SOS/Input 1 Active</b>	Report when input1 (SOS) is active/pressed.
<b>Input 2 Active</b>	Report when input 2 is active.
<b>Input 3 Active</b>	Report when input 3 is active.
<b>SOS/Input1 Inactive</b>	Report when input 1 inactive (SOS released).
<b>Input 2 Inactive</b>	Report when input 2 inactive.
<b>Input 3 Inactive</b>	Report when input 3 inactive.
<b>Low Battery</b>	Report when backup battery's voltage is below 3.5V.
<b>Low External Power</b>	External power (car battery) is lower than predefined voltage. You can define voltage in Main Settings.
<b>Speeding</b>	Report when MVT600 speeds higher than the pre-set value. Value can be changed on tap III <b>Main Settings</b>
<b>Enter Geo-fence</b>	Report when MVT600 enters Geo-fence.
<b>Exit Geo-fence</b>	Report when MVT600 exits Geo-fence. Geo-fence can be changed on tap III <b>Main Settings</b> .
<b>External Power On</b>	Alarm when external power supply is on or recover.
<b>External Power Off</b>	Alarm when external power supply if off or cut.
<b>No GPS Signal</b>	Report when MVT600 enters GPS blind area or no GPS signal.
<b>Get GPS Signal</b>	Report when MVT600 exits GPS blind area or get GPS signal.
<b>Enter Sleep</b>	Report when MVT600 enters sleep mode.
<b>Exit Sleep</b>	Report when MVT600 exits sleep mode. Sleep mode can be changed on tap III <b>Main Settings</b> .
<b>GPS Antenna Cut</b>	Alarm when the GPS antenna is disconnected or cut
<b>Device Reboot</b>	Report when MV600 is rebooting.



File Name:	MEITRACK MVT600 User Guide	Creator:	Cavana Cheung
Project:	MVT600	Creation Date:	2010-09-13
		Update Date:	2013-06-26
Sub Project:	User Guide	Page:	- 17 - of 22
Revision:	V3.0	Confidential:	External Documentation

<b>Heartbeat Report</b>	Turn on heartbeat report You can define heartbeat interval on tap III <b>Main Settings</b> .
<b>Heading Change Report</b>	Auto report when MVT600's direction changes over predefined angle You can define angle degree on tap III <b>Main Settings</b> .
<b>Distance Interval Report</b>	Track by distance. Interval can be changed on tap III <b>Main Settings</b> .
<b>Tow Alarm</b>	Alarm when the tracker trembles for a period of time. You can define tow time on tap III <b>Main Settings</b> .
<b>RFID</b>	RFID data.

For more information about GPRS settings, please refer to MEITRACK SMS/GPRS Protocol.

## 7 Installation

### 7.1 Install I/O Cable

The I/O cable is a 12-pin cable including power, analog input, negative/positive input and output.



I/O					
1 Power(+)	3 Input 3	5 Input 2	7 Output 1	9 Output 2	11 Output 3
2 GND(-)	4 Input 1 (-)	6 GND(-)	8 AD Input 1	10 AD Input 2	12 AD Input 3

PIN Number	Color	Description
<b>1 (Power)</b>	Red	DC In (power source). Input voltage: 9V~36V. 12V suggested
<b>2 (GND)</b>	Black	Ground
<b>3 (IN3)</b>	White	Digital Input3. Positive triggering, for detecting status of vehicle door or ACC.
<b>4 (IN1)</b>	White	Digital Input1. Negative triggering( Defaulted as SOS Panic Button)
<b>5 (IN2)</b>	White	Digital Input2. Negative triggering, for detecting status of vehicle door.
<b>6 (GND)</b>	Black	Ground. It can be used to connect with temperature/fuel sensor etc.
<b>7 (OUT1)</b>	Yellow	Output1. It can be used to connect with relay for engine immobilization. Low voltage (0V) when effective and open drain when ineffective. Output open drain sink voltage (ineffective): 45V max.

File Name:	MEITRACK MVT600 User Guide	Creator:	Cavana Cheung
Project:	MVT600	Creation Date:	2010-09-13
		Update Date:	2013-06-26
Sub Project:	User Guide	Page:	- 18 - of 22
Revision:	V3.0	Confidential:	External Documentation

		Output low voltage sink current (effective): 500mA max
<b>8 (AD1)</b>	Blue	12 Bits Resolution Analog Input1. 0~6V DC Detection. It can be used to connect with temperature/fuel sensor etc.
<b>9 (OUT2)</b>	Yellow	Output2. It can be used to connect with relay for engine immobilization. Low voltage (0V) when effective and open drain when ineffective. Output open drain sink voltage (ineffective): 45V max. Output low voltage sink current (effective): 500mA max.
<b>10 (AD2)</b>	Blue	12 Bits Resolution Analog Input2. 0~6V DC Detection. It can be used to connect with temperature/fuel sensor etc.
<b>11 (OUT3)</b>	Yellow	Output3. It can be used to connect with relay for engine immobilization. Low voltage (0V) when effective and open drain when ineffective. Output open drain sink voltage (ineffective): 45V max. Output low voltage sink current (effective): 500mA max.
<b>12 (AD3)</b>	Blue	12 Bits Resolution Analog Input3. 0~6V DC Detection. It can be used to connect with relay for engine immobilization.

#### Power/GND (PIN1/PIN2)

Connect GND (-Black) and Power (+Red) wires to the battery of vehicle.

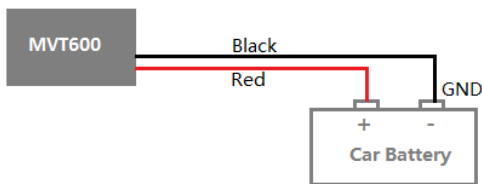

#### 7.1.2 Digital Input (PIN4/5, negative triggering)

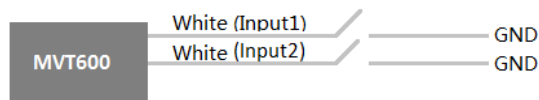

#### 7.1.3 Digital Input (PIN3, positive triggering)

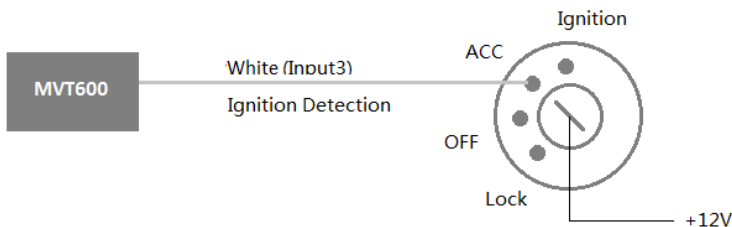

File Name:	MEITRACK MVT600 User Guide	Creator:	Cavana Cheung
Project:	MVT600	Creation Date:	2010-09-13
Sub Project:	User Guide	Update Date:	2013-06-26
Revision:	V3.0	Page:	- 19 - of 22
		Confidential:	External Documentation

### 7.1.4 Output

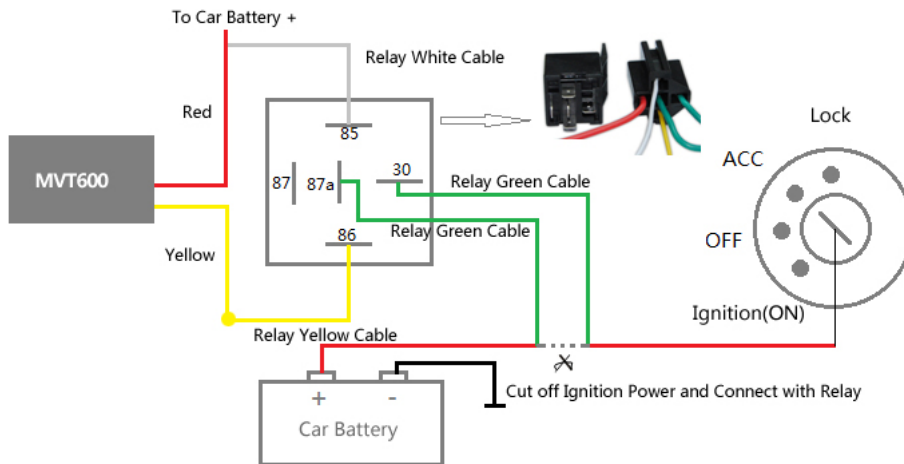

### 7.1.5 Analog Input

#### 7.1.5.1 Analog Input Application 1– Detect External Power Voltage

Input range: 0-6V

Voltage Calculating Formula:  $\text{input voltage} = (\text{AD} \times 3.3 \times 2) / 4096$

$0x0C9B \Rightarrow 3227(\text{decimal}) \Rightarrow (3227 \times 3.3 \times 2) / 4096 = 5.1997\text{V}(\text{voltage})$

$0x0D9D \Rightarrow 3845(\text{decimal}) \Rightarrow (3845 \times 3.3 \times 2) / 4096 = 5.6154\text{V}(\text{voltage})$

#### 7.1.5.2 Analog Input Application 2 – Fuel Detection (percentage of fuel)

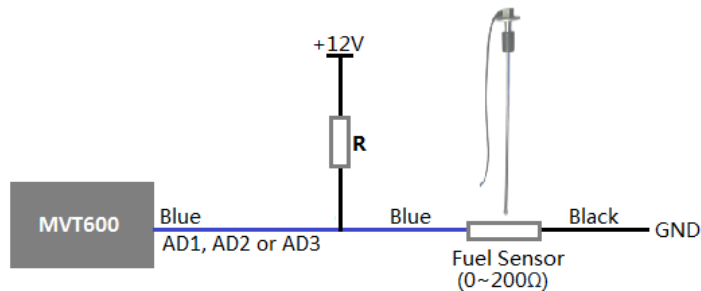

Note:

Fuel level sensors supplied by us are resistance-type sensors with output resistance: 0-200Ω (ohm).

For the circuit shown on above figure, if VCC is 12V, R should be 200Ω (ohm) and if VCC is 24V then R should be 600Ω (ohm) to make the input range to AD1 or AD2 is 0-6V.

Below formula is for calculating the fuel percentage left for this fuel level sensor:

$$\text{Percentage Left} = \frac{1.1 \times \text{AD value}}{4096 \times 2 - 1.1 \times \text{AD value}} \times 100\%$$

The value must be converted into decimal, for example, 0x0313 is 787 in decimal, the results is 11.82%.

File Name:	MEITRACK MVT600 User Guide	Creator:	Cavana Cheung
Project:	MVT600	Creation Date:	2010-09-13
		Update Date:	2013-06-26
Sub Project:	User Guide	Page:	- 20 - of 22
Revision:	V3.0	Confidential:	External Documentation

### 7.1.6 Install Handset Phone (RS232 Interface)



PIN Number	Color	Description
1	Red	Power Output. Output Voltage: 5V
2	Black	Ground
3	White	Handset Phone RS232 TX (MVT600 RX)
4	Yellow	Handset Phone RS232 RX (MVT600 TX)
5	Orange	Microphone Positive
6	Grey	Microphone Negative
7	Purple	Speaker Positive
8	Brown	Speaker Negative

Note: This interface also supports LCD display; navigator provided conforms to MEITRACK Protocol.

### 7.1.7 Install Camera (RS232 Interface)



#### Camera1 RS232 Interface

PIN Number	Color	Description
1	Red	Power Output. Output Voltage: 5V
2	Black	Ground
3	Yellow	Camera RS232 TX (MVT600 RX)
4	Green	Camera RS232 RX (MVT600 TX)

#### Camera2 RS232 Interface

PIN Number	Color	Description
1	Red	Power Output. Output Voltage: 5V
2	Black	Ground
3	Yellow	Camera RS232 TX (MVT600 RX)
4	Green	Camera RS232 RX (MVT600 TX)

File Name:	MEITRACK MVT600 User Guide	Creator:	Cavana Cheung
Project:	MVT600	Creation Date:	2010-09-13
		Update Date:	2013-06-26
Sub Project:	User Guide	Page:	- 21 - of 22
Revision:	V3.0	Confidential:	External Documentation

GPS RS232 Data Interface		
PIN Number	Color(Suggested)	Description
1	Red	Power Output. Output Voltage: 5V
2	Black	Ground
3	Yellow	RS232 Interface TX (MVT600 RX)
4	Green	RS232 Interface RX (MVT600 TX)

Note: Micro SD is required for taking photos.

### 7.1.8 Install Micro SD

There's a Micro SD card slot under the On/Off button. Micro SD card can be used to store the pictures taken by the camera.



### 7.1.9 Install RFID Reader (Wiegand Interface)



PIN Number	Color	Description
1	Red	Power Output. Output Voltage: 5V
2	Black	Ground
3	Green	RFID Data0
4	Yellow	RFID Data1

### 7.2 Install GPS/GSM Antennas



GPS Antenna

GSM Antenna

Connect the GSM antenna to the SMA connector which is 'GSM' text labeled. The GSM antenna is non-directional, so you can hide it in any place of vehicle.

File Name:	MEITRACK MVT600 User Guide	Creator:	Cavana Cheung
Project:	MVT600	Creation Date:	2010-09-13
		Update Date:	2013-06-26
Sub Project:	User Guide	Page:	- 22 - of 22
Revision:	V3.0	Confidential:	External Documentation

Connect GPS antenna to the GPS connector which is 'GPS' labeled. The optimum location for the GPS antenna is on the roof of the vehicle. The covert and GPS antenna are directional, make sure they are facing up and lying as flat as possible. Secure them in place with glue or zip ties.

Note: Do not shield or cover the GPS antenna with any objects containing metal.

### 7.3 Mount the MVT600 unit

If mounting required, there are 4 screw holes on the MVT600, 2 along either side that act as fixing points to the vehicle



Please do not hesitate to email us at [info@meitrack.com](mailto:info@meitrack.com) if you have any questions.